

High efficiency shoulder milling cutter

SEC-WaveMill WSE Series

Ideal for high-efficiency machining of titanium alloys, such as aerospace components



A selection of corner radiuses capable of handling large ramping angles



■ Features

- Ideal for machining titanium alloys for aerospace
Designed for machining at large ramping angles, coupled with a selection of corner radii, makes it applicable for a variety of applications including titanium structural parts
- Stable and long tool life in machining titanium alloys
The optimized cutting edge shape together with newly developed ACS2500/ACS3000 grades (for machining exotic alloys) result in excellent wear resistance and fracture resistance
- Optimized cutting edge shape and chip pocket for excellent chip evacuation

■ Product Range

Number in ●●● shows the number of teeth

Type	Description	Cat. No.	Dia. (mm)		
			ø32	ø50	ø63
Shell	Standard	WSE 16000RS●●		●5	●6
	Long	WSE 16000RS●●L		●5	●6
Shank	Standard	WSE 16000E●●	●3		

■ Applicable to various applications!

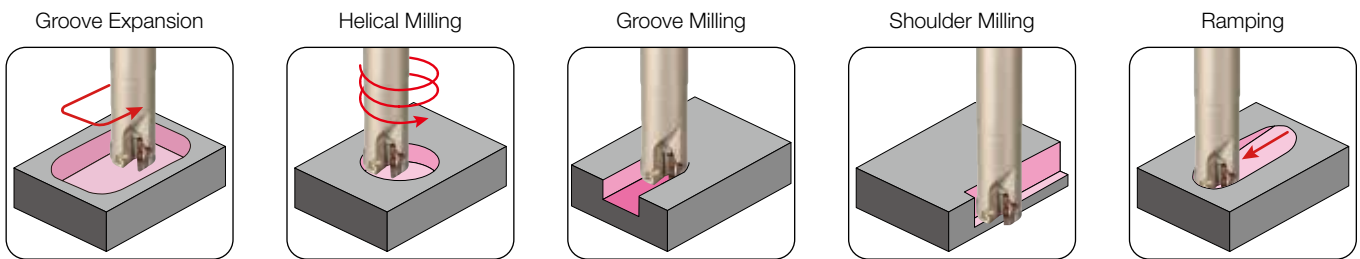

■ Ramping/Helical Milling Upper Limit

Ramping

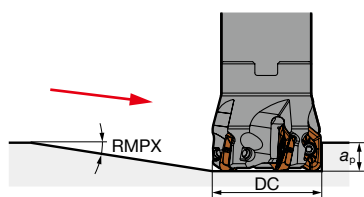

Flat bottom machining

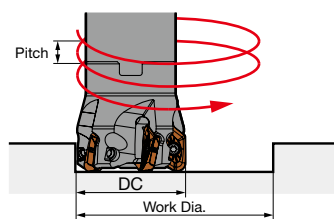

Machining with prepared hole

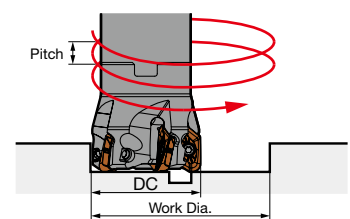

Dia. DC ø (mm)	Corner Radius RE	Max. Ramping Angle RMPX (°)
32	RE ≥ 5.0	8.4
	RE ≤ 4.0	12.2
50	RE ≥ 5.0	3.6
	RE ≤ 4.0	5.6
63	RE ≥ 5.0	2.5
	RE ≤ 4.0	3.9

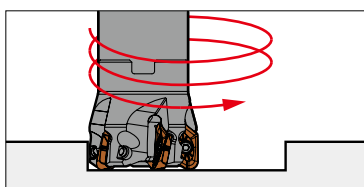

Dia. DC ø (mm)	Corner Radius RE	Max. Hole Dia. ø (mm)	Max. Pitch (mm/rev)	Standard Work Dia. ø (mm)	Max. Pitch (mm/rev)	Min. Machining Dia. ø (mm)	Max. Pitch (mm/rev)
32	4.0	55.3	13.0	55.2	13.0	45.9	3.0
	0.8	61.3	13.0	56.3	13.0	45.9	2.9
50	4.0	91.6	11.2	91.6	11.2	81.9	2.8
	0.8	97.3	13.0	92.2	11.0	81.9	2.7
63	4.0	117.6	10.1	117.6	10.1	107.9	2.7
	0.8	123.3	11.7	118.2	9.9	107.9	2.6

Precautions for Flat Bottom Machining





- For flat bottom machining, if the work diameter is smaller than the minimum machining diameter, there will be a centre uncut portion.
- A prepared centre hole should be made.
- Above the maximum machining diameter, this portion can be removed by traverse cutting with the same cutter.

Grade Features

Work Material	Grade	Coating Thickness (µm)	Features
	ACS2500	3	Carbide substrate with excellent wear and adhesion resistance, coupled with a chipping resistant coating, provide outstanding performance especially in machining titanium alloys
	ACS3000	3	High toughness carbide substrate and a coating with excellent chipping resistance provide outstanding stability when machining titanium alloys, heat-resistant alloys or stainless steel

Grade Application Range

The newly developed **ACS2500/ACS3000** grades ideal for machining titanium alloys, heat-resistant alloys and stainless steel are now available!

Work Material		Finishing to Light Cutting	Medium Cutting	Rough to Heavy Cutting
 	Coated Carbide	ACS2500		
	Coated Carbide		ACS3000	

New PVD Coating Features

ABSOTECH
PVD

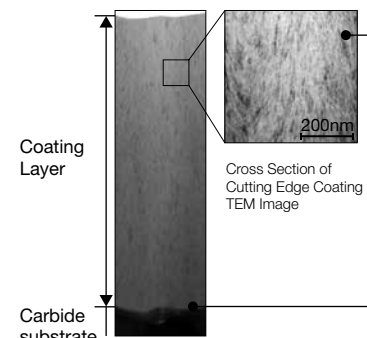





Ultra-fine grained B additive

- New AlTiBN coating, with an ultra-fine coating structure, achieves high strength and toughness
- Outstanding chipping resistance and wear resistance





High Adhesion Strength

Significantly improved coating adhesion and more than 2x conventional chipping resistance

Chipbreaker Shape

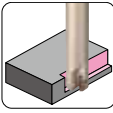
Work Material	 Stainless Steel,  Exotic Alloy
Applications	General-purpose to roughing
Features	Standard
Chipbreaker	E type 
Cutting Edge Cross Section	

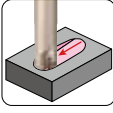
Excellent Chip Control

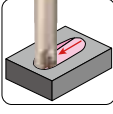
Cutting Conditions	Chip	
$v_c = 60\text{m/min}$ $f_z = 0.12\text{mm/t}$ $a_p = 10\text{mm}$ $a_e = 21\text{mm}$ Wet (7MPa) Ramping Angle: 0°	 Stable Chip Control WSE Type	 Unstable Chips Competitor's Product
$v_c = 50\text{m/min}$ $f_z = 0.12\text{mm/t}$ $a_p = 4\text{mm}$ $a_e = 50\text{mm}$ Wet (7MPa) Ramping Angle: 3°	 Stable Chip Control WSE Type	 Unstable Chips Competitor's Product
$v_c = 50\text{m/min}$ $f_z = 0.12\text{mm/t}$ $a_p = 4\text{mm}$ $a_e = 50\text{mm}$ Wet (7MPa) Ramping Angle: 5.5°	 Stable Chip Control WSE Type	X Machining Not Possible Competitor's Product

Machine : 5-axis Machine HSK100, Work Material: Ti-6Al-4V
 Tool : WSE 16050RS05L (ø50, 5-tooth)
 Insert : XOMT160540PEER-E (ACS3000)

Rake Angle	Radial	-9° to -6°	15mm	90°
	Axial	8° to 14°		

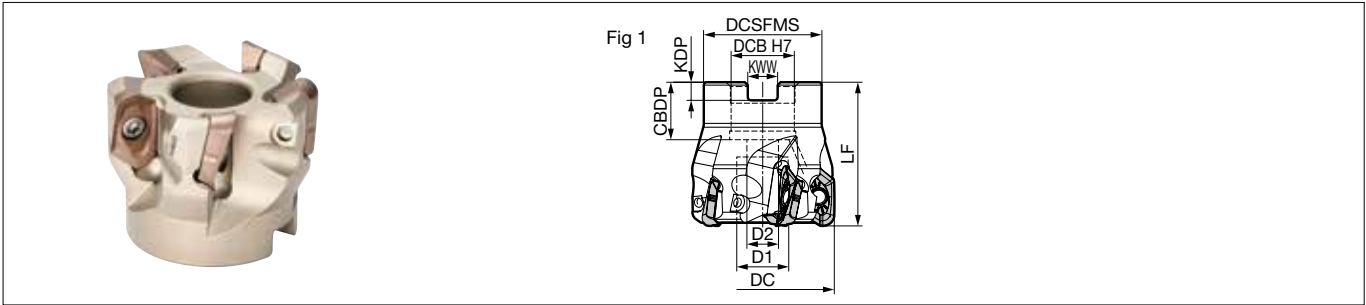

■ Body (Shell Type)

Dimensions (mm)

	Cat. No.	Stock	Dia. DC	Boss DCSFMS	Height LF	Hole Dia. DCB	Keyway Width KWW	Keyway Depth KDP	Mounting Depth CBDP	Bolt D1	Bolt D2	Number of Teeth	Weight (kg)	Fig
Metric	WSE 16050RS05	○	50	41	40(38.5)	22	10.4	6.3	20	18	11	5	0.24	1
	16050RS05L	○	50	41	50(48.5)	22	10.4	6.3	20	18	11	5	0.33	1
	16063RS06	○	63	50	40(38.5)	22	10.4	6.3	20	18	11	6	0.46	1
	16063RS06L	○	63	50	50(48.5)	22	10.4	6.3	20	18	11	6	0.61	1

The LF dimensions in parentheses are dimensions using RE = 5.0 or higher inserts. When using RE = 5.0 or higher inserts, the maximum depth of cut is 13mm. Take note of the cutter mounting size (DCB) when selecting a cutter. Inserts are sold separately.

■ Identification Code

WSE 16 050 R S 05 L

Series Insert Size Dia. Feed Direction Metric Bore Number of Teeth Long

■ Parts

Flat Insert Screw		Detachable Wrench		Anti-seizure Cream
		Handle Grip	Bit	
BFTX0409IP	3.0	HPS1015	TRB15IP	SUMI-P

Insert

Dimensions (mm)

Process	Grade Classification		Coated Carbide		Corner Radius RE	Fig
	High-speed/Light	Medium Cutting	M	S		
		Roughing		M		
	Cat. No.	ACS2500	ACS3000			
	XOMT 160508PEER-E	○	○		0.8	1
	160512PEER-E	○	○		1.2	1
	160516PEER-E	○	○		1.6	1
	160520PEER-E	○	○		2.0	1
	160530PEER-E	○	○		3.0	1
	160540PEER-E	○	○		4.0	1
	160550PEER-E	○	○		5.0	2
	160560PEER-E	○	○		6.0	2
	160564PEER-E	○	○		6.35	2

Fig 1

Fig 2

Precautions for Mounting Inserts

- (1) Clean the mounting seat surface and contact parts.
- (2) While pressing the insert firmly against the seat surface, tighten the screws with the included wrench.
- (3) Apply Anti-seizure Cream to the screws and tighten at the recommended torque.
- (4) After tightening, check that there are no gaps on the seat surface.

***Modification of the cutter body is required when mounting an insert with corner radius 5.0 or higher.**

Recommended Cutting Conditions

ISO	Work Material		Hardness	Chipbreaker	Cutting Speed v_c (m/min) Min. - Optimum - Max.	Feed Rate f_z (mm/t) Min. - Optimum - Max.	Grade
S	Exotic Alloy	Heat-Resistant Alloy	—	E	25 - 35 - 50	0.05 - 0.10 - 0.15	ACS2500/ACS3000
		Ti Alloy	—	E	30 - 60 - 90	0.05 - 0.10 - 0.15	ACS2500/ACS3000
M	Stainless Steel	X6Cr17 and Others (Martensitic/Ferritic)	200	E	115 - 145 - 175	0.05 - 0.10 - 0.15	ACS2500/ACS3000
		X6Cr13 and Others (Martensitic/Hardened)	240	E	105 - 130 - 155	0.05 - 0.10 - 0.15	ACS2500/ACS3000
		X5CrNi18-10, X5CrNiMo17-12-2 (Austenitic)	180	E	125 - 155 - 190	0.05 - 0.10 - 0.15	ACS2500/ACS3000

- The recommended cutting conditions may not be practical depending on the operating conditions (e.g. machine, work material shape, clamping system).
- For groove milling, adjust the feed rate to around 70% of the above values.

Note The cutting conditions above are a guide. Actual conditions will need to be adjusted according to machine rigidity, work clamp rigidity, depth of cut and other factors.

Rake Angle	Radial	-9°	15mm 90°
	Axial	8°	

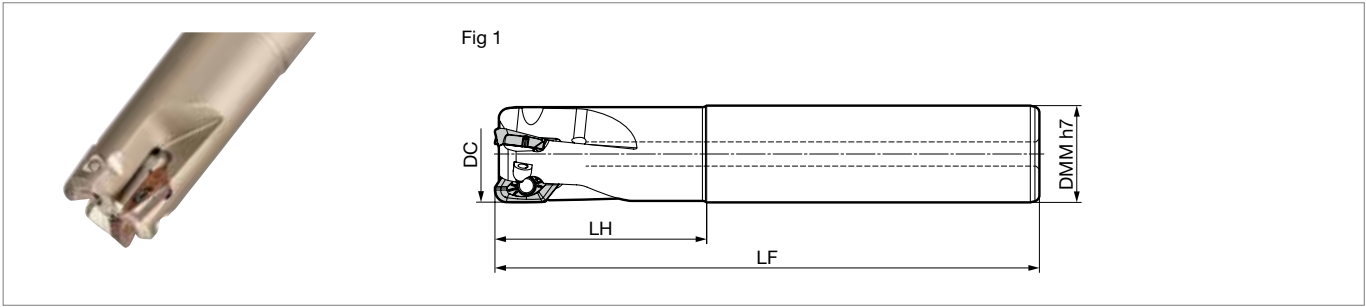

■ Body (Shank Type)

Dimensions (mm)

Cat. No.	Stock	Dia. DC	Shank DMM	Head LH	Overall Length LF	Number of Teeth	Weight (kg)	Fig
WSE 16032E03	○	32	32	60(58.4)	170(168.4)	3	0.90	1

The LH and LF dimensions in parentheses are dimensions using RE = 5.0 or higher inserts. When using RE = 5.0 or higher inserts, the maximum depth of cut is 13mm. Inserts are sold separately.

■ Identification Code

WSE 16 032 E 03

Series Insert Size Dia. Shank Type Number of Teeth

■ Parts

Flat Insert Screw	Wrench	Anti-seizure Cream
BFTX0409IP	3.0	TRDR15IP SUMI-P

Insert

Dimensions (mm)

Process	Grade Classification		Coated Carbide		Corner Radius RE	Fig
	High-speed/Light	Medium Cutting	M	S		
		Roughing		M		
	Cat. No.	ACS2500	ACS3000			
	XOMT 160508PEER-E	○	○	0.8	1	
	160512PEER-E	○	○	1.2	1	
	160516PEER-E	○	○	1.6	1	
	160520PEER-E	○	○	2.0	1	
	160530PEER-E	○	○	3.0	1	
	160540PEER-E	○	○	4.0	1	
	160550PEER-E	○	○	5.0	2	
	160560PEER-E	○	○	6.0	2	
	160564PEER-E	○	○	6.35	2	

Fig 1

Fig 2

Precautions for Mounting Inserts

- (1) Clean the mounting seat surface and contact parts.
- (2) While pressing the insert firmly against the seat surface, tighten the screws with the included wrench.
- (3) Apply Anti-seizure Cream to the screws and tighten at the recommended torque.
- (4) After tightening, check that there are no gaps on the seat surface.

***Modification of the cutter body is required when mounting an insert with corner radius 5.0 or higher.**

Recommended Cutting Conditions

ISO	Work Material		Hardness	Chipbreaker	Cutting Speed v_c (m/min) Min. - Optimum - Max.	Feed Rate f_z (mm/t) Min. - Optimum - Max.	Grade
S	Exotic Alloy	Heat-Resistant Alloy	—	E	25 - 35 - 50	0.05 - 0.10 - 0.15	ACS2500/ACS3000
		Ti Alloy	—	E	30 - 60 - 90	0.05 - 0.10 - 0.15	ACS2500/ACS3000
M	Stainless Steel	X6Cr17 and Others (Martensitic/Ferritic)	200	E	115 - 145 - 175	0.05 - 0.10 - 0.15	ACS2500/ACS3000
		X6Cr13 and Others (Martensitic/Hardened)	240	E	105 - 130 - 155	0.05 - 0.10 - 0.15	ACS2500/ACS3000
		X5CrNi18-10, X5CrNiMo17-12-2 (Austenitic)	180	E	125 - 155 - 190	0.05 - 0.10 - 0.15	ACS2500/ACS3000

- The recommended cutting conditions may not be practical depending on the operating conditions (e.g. machine, work material shape, clamping system).
- For groove milling, adjust the feed rate to around 70% of the above values.

Note The cutting conditions above are a guide. Actual conditions will need to be adjusted according to machine rigidity, work clamp rigidity, depth of cut and other factors.

Application Examples

Titanium Alloy Ti-6Al-4V Aerospace Component	Sumitomo	Competitor's Product
	Tool	WSE16050RS05L Single-Sided, 2 Corners
	Grade	ACS3000
	Insert	XOMT160540PEER-E
	Cutter Dia. (mm)	50
	Number of Teeth	5
	v_c (m/min)	50
	v_f (mm/min)	191
	f_z (mm/t)	0.12
	a_p (mm)	4
	a_e (mm)	10
	Coolant	Wet
	Results	Although cutting edge chipping resulted in an unstable tool life, WSE Type suppresses fractures for double the tool life of competitor's product

Titanium Alloy Ti-6Al-4V Aerospace Component	Sumitomo	Competitor's Product
	Tool	WSE16050RS05L Single-Sided, 2 Corners
	Grade	ACS3000
	Insert	XOMT160540PEER-E
	Cutter Dia. (mm)	50
	Number of Teeth	5
	v_c (m/min)	75
	v_f (mm/min)	287
	f_z (mm/t)	0.12
	a_p (mm)	10
	a_e (mm)	25
	Coolant	Wet
	Results	Tool life was similar to competitor's under the same cutting conditions, but with the change of cutting conditions, tool life was doubled with the same efficiency

Titanium Alloy Ti-6Al-4V Aerospace Component	Sumitomo	Competitor's Product
Vertical Machining Centre BT50 	Tool	WSE16050RS05L Single-Sided, 2 Corners
	Grade	ACS3000
	Insert	XOMT160520PEER-E
	Cutter Dia. (mm)	50
	Number of Teeth	5
	v_c (m/min)	32
	v_f (mm/min)	102
	f_z (mm/t)	0.1
	a_p (mm)	3 to 10
	a_e (mm)	35 to 50
	Coolant	Wet
	Results	Sudden fractures suppressed for a stable tool life



(Germany)
SUMITOMO ELECTRIC Hartmetall GmbH
Konrad-Zuse-Straße 9, 47877 Willich

Tel. +49 2154 4992-0, Fax +49 2154 4992-161
Info@SumitomoTool.com
www.SumitomoTool.com



(UK and Ireland)
SUMITOMO ELECTRIC Hardmetal Ltd.
3 Paper Mill Drive
Redditch, B98 8QJ, UK

Tel. +44 1844 342081, Fax: +44 1844 342415
InfoUK@SumitomoTool.com
www.SumitomoTool.com

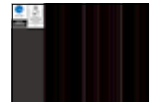

Distributed by: